

datavideo

4K UHD

 CAST mini

4K Dual Channel  
Presentation Switcher



[www.datavideo.com](http://www.datavideo.com)





# Dual Channel Presentation Switcher

## Improve the quality of your online presentations!

Datavideo's iCAST MINI is a multimedia device designed for single-operator applications. From small scale corporate training sessions to mid-sized hybrid classrooms or conference halls, the iCAST MINI is the perfect fit for your online presentation needs.. The iCAST MINI is a newly innovative solution for one-to-one, one-to-many and hybrid (online/offline) video productions. With the one-button-one-function feature on a unique and easy to use touch panel control, even novice users will be able to easily operate this device. You don't need to learn complicated technologies about video production or hire a professional production team. You can take control on your own presentations with the iCast Mini. Simply connect the power and the video sources, then leave the rest to the iCast Mini.





4K UHD



42.5%  
40%  
37.5%  
35%  
32.5%  
30%  
27.5%  
25%  
22.5%  
20%  
17.5%  
15%  
12.5%  
10.0%  
7.5%

TOKEN

## Control Panel

Home



## Rear Panel

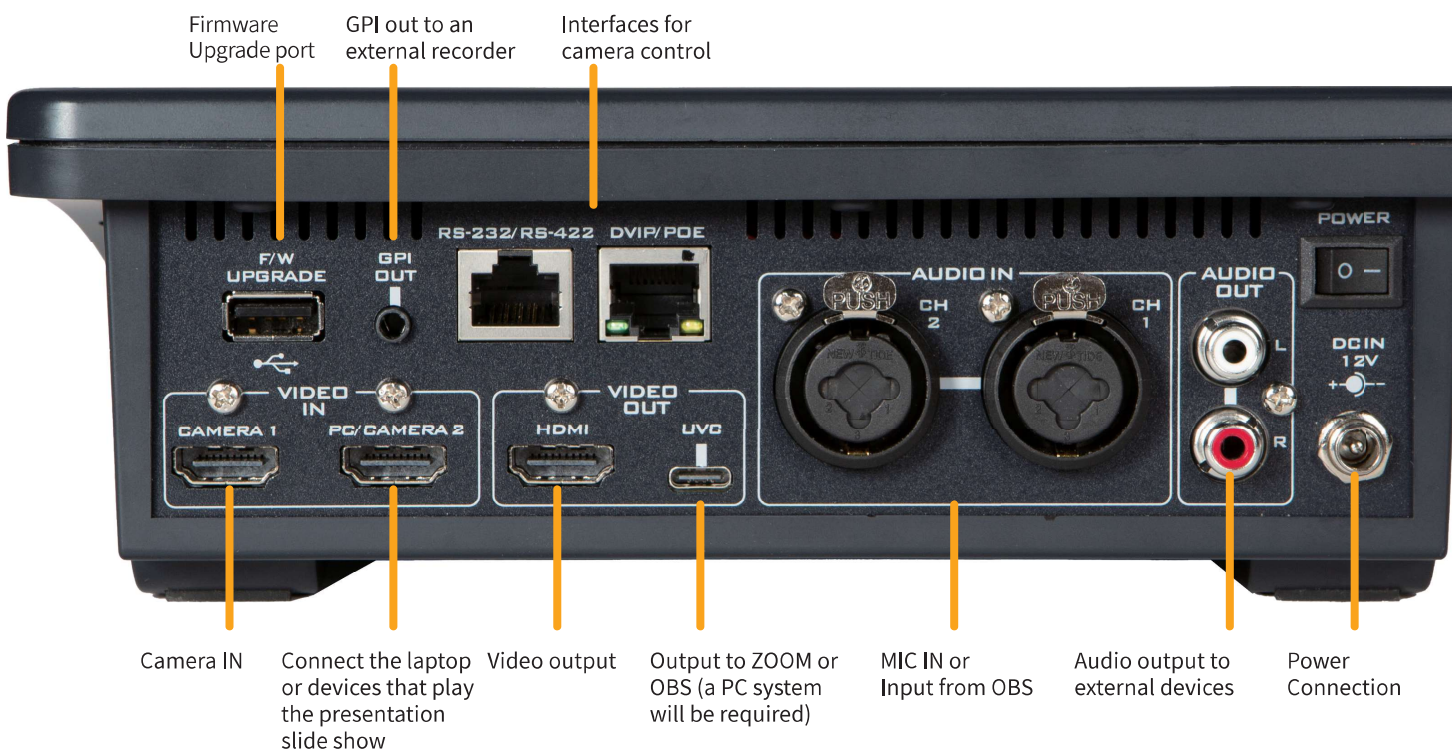



### Camera control



### PIP Settings

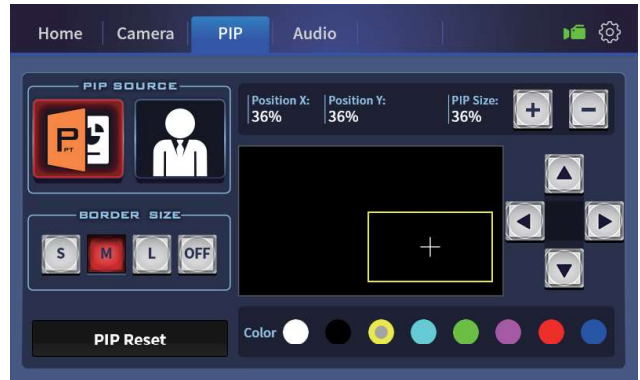

### Audio Settings



### System Settings

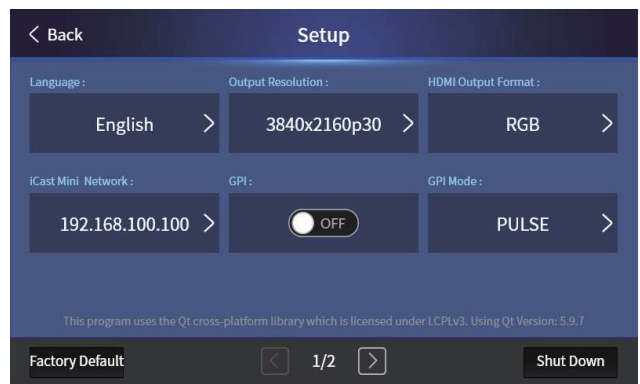

Output to a headphone or stereo speakers

## Small to mid-sized meetings



### Small to mid-sized meetings

As the most commercial application which includes product presentations, a wide variety of project tracking meetings and internal announcements, small to mid-sized meetings require an easy-to-use equipment that is readily accessible to all presenters. The iCAST MINI's PIP function allows display of meeting contents on the image of the speaker so that the information can be clearly and correctly conveyed to the audience.

### Corporate Training

Just like any small-sized classrooms, corporate trainings rely heavily on peripheral devices. Most traditional training sessions are conducted with a laptop and materials are taught in person to a group of people in a classroom. Soemtimes, when a device demonstration is required, the presenter will not be able to switch between the demonstration and class materials rapidly because of the lack of an appropriate device. Most traditional switchers require a complicated system setup and are therefore an convenience for the presenter. The iCAST MINI is designed specifically for small classes. Its versatile input video switching and simplified workflow allow you to easily switch between different views of training contents and device demonstrations. Its light weight makes video switching versatile and you can operate the device with a few taps on a control touch panel.



# Corporate training



# Hybrid Classroom



## Hybrid Classroom

In the recent years, traditional classroom teaching has encountered significant changes. It is not only about conveying information in a classroom, you must also get your information across any networks. As such, the teachers have to make corresponding changes. In order to make sure information reaches all students whether they are at home or in person; we've included various unique graphic keyers on iCAST MINI. Visual operations aim to minimize interruptions to teaching. With the PTC-145/285 AI PTZ cameras, you will be able to further minimize interruptions and allow teachers to focus on teaching.









# One USB Type C cable to merge online and offline teaching

The most widely used platforms for hybrid classrooms are ZOOM, Microsoft Teams, and Google Meet. ZOOM in particular is the most popular platform due to its efficient audio-video streaming. Without changing the current classroom setting, the iCAST MINI will be able to deliver the video along with the audio to the above-mentioned platforms via the UVC interface with a USB type C cable. You don't need to install drivers or perform any calibrations and extra device configuration. The iCAST MINI allows you to stream your classroom images as well as the teaching materials to various locations so that students on the other end of the network will be able to learn with high efficiency in a quality environment.

Watch live on the big screen



laptop to conduct

UVC to PC





HDMI



remote via network  
participate in the meeting

## Graphical User Interface on Touch Panel



An intuitive graphical user interface on a 7 inch touch panel with an anti-fingerprint protection provides you with the best color screen view at any angles and operation experience.

## Videos and PIP Mode

Switch rapidly between your presentation and the camera videos or overlay a PIP window on the program video. You can also swap between the program out video and the PIP image, thereby enhancing the versatility of video switching with the easiest way.

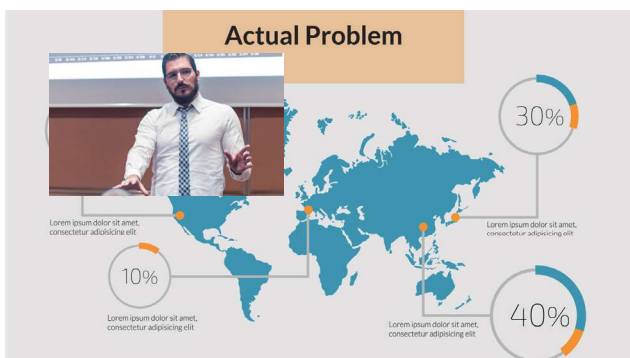
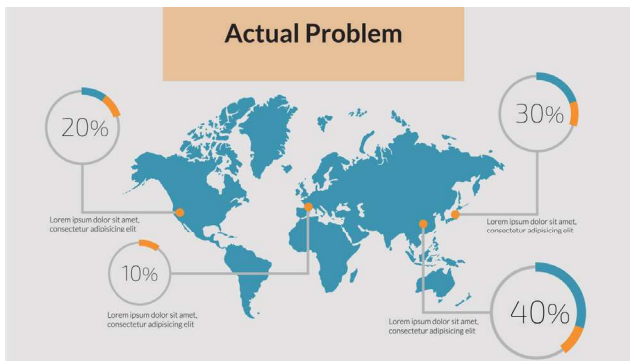



# Images for key icons for easier identification

Using a real image as your key icon allows you to intuitively identify the camera view that is saved in the key. You can capture camera images and save them as different still image files which are in turn applied to icons of shortcut keys on the Home screen. You can use these images as the icons for all four camera presets so that by simply pressing these preset keys, you will be able to return the camera to the pre-saved position from the current view. With these still images as the icons, you don't have to recall what has been saved in the presets. By simply looking at these real images, you will be able to easily identify the saved PTZ settings.

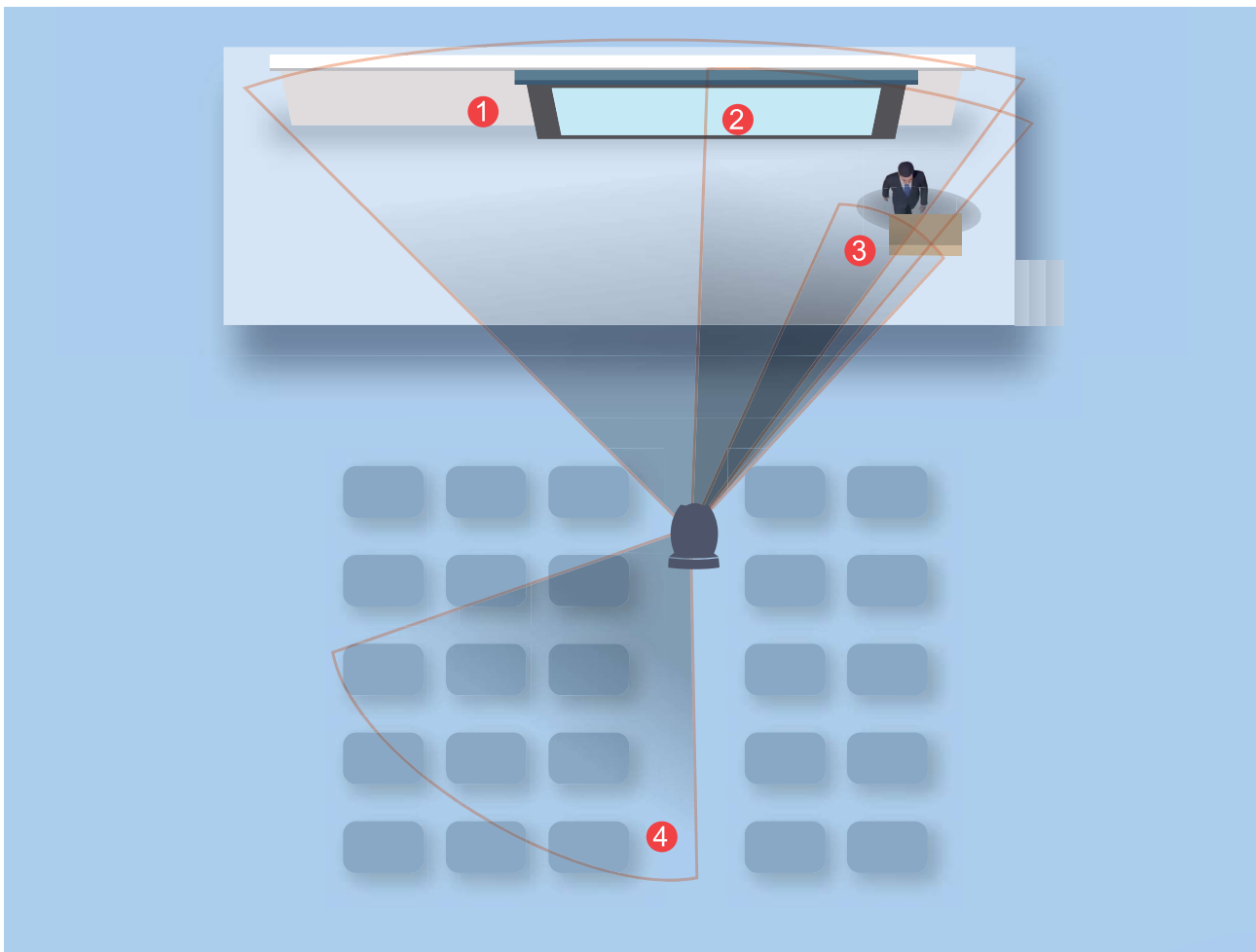

## Graphic icon for keys to simplify workflow



Sometimes there is only a slight difference between the images used for key icons, thus causing confusions during video production. As such, you can use the device's built-in graphical icons for better identification. We've pre-saved hundreds of these icons on the device and compared to textual icons, they are more appropriate and intuitive. Of course, these graphical icons can co-exist with the image icons. They not only simplify your workflow but also reduce the number of errors made. They make your operation faster and easier each time.

## User Image Swap

The graphical icons can also be applied to icons of user memory presets for easier identification of the parameters saved therein. There are up to 100 icons available for all users.

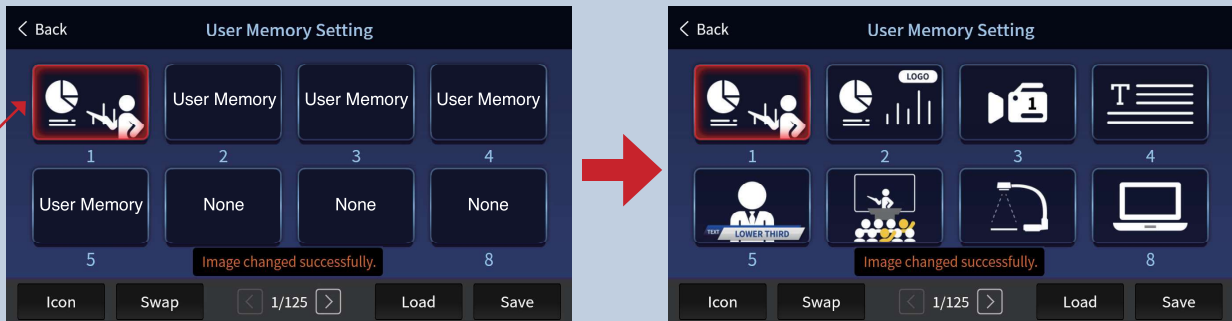

Up to 102 icons.



# You need a camera that understands your needs

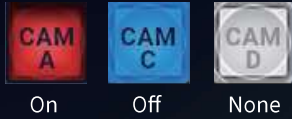

PTC-145

## Auto Tracking Mode

With Datavideo's PTC-145 (HD) or PTC-285 (4K UHD) Smart Auto Tracking PTZ camera, you will have a more pleasant experience in iCAST MINI operations. Your only responsibility is to create a presentation and get the cameras ready. The PTC-145/285 will be able to capture desired images with its advanced auto tracking function. You can pre-save camera settings for long, medium and close up shots so that the camera will automatically loads the desired image size for you.

### Using non PTZ cameras



When using the iCAST MINI with Datavideo's BC-15P or other non PTZ cameras, you can hide the camera presets on the UI and simply display panes that allow you to switch between camera images and presentation contents which can be swapped with PIP images. In this way, the keys are enlarged to facilitate operations.

### PTZ Cameras with Auto Tracking

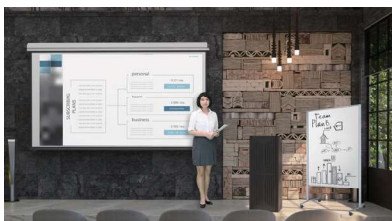

Full body



Half body



Close up

Datavideo's PTC-145/285 Smart PTZ cameras allow you to switch between full body, half body and close up shots. Once the smart tracking function takes over, the camera will be able to more precisely determine the appropriate shots for your video production job.



### About auto tracking PTZ cameras

In addition to iCAST MINI, Datavideo also provides various devices that offer different degrees of control over auto tracking on cameras. If you need to rapidly enable/disable the smart camera's auto tracking function, you can use the supplied RMC-1 remote control, RMC-300A controller, RMC-180 MARK II controller with an RS-422 interface, PTC View Assist, TPC-700, etc for your applications. If you would like to use a controller with the video switching function, available choices are KMU-200, SHOWCAST 100 and iCAST MINI. They will make your video production workflow more complete.





### Self-defined object to be auto tracked

If in your camera image, there are multiple objects, you can customize the settings such that only the target object is auto tracked by the smart AT camera. Basically, a relational model between the tracked target object and the camera will be defined so that even when noises such as desks, unnecessary objects, people, etc appear in the camera image, the AT smart tracking system will still lock onto the configured speaker or object.



### Pan, tilt and zoom the smart camera

A PID driven algorithm is able to adjust the pan, tilt and zoom tracks and speeds according to movements of the tracked object, thus mimicking smooth human operation of the lens and avoiding sudden acceleration or halt of the lens motion.

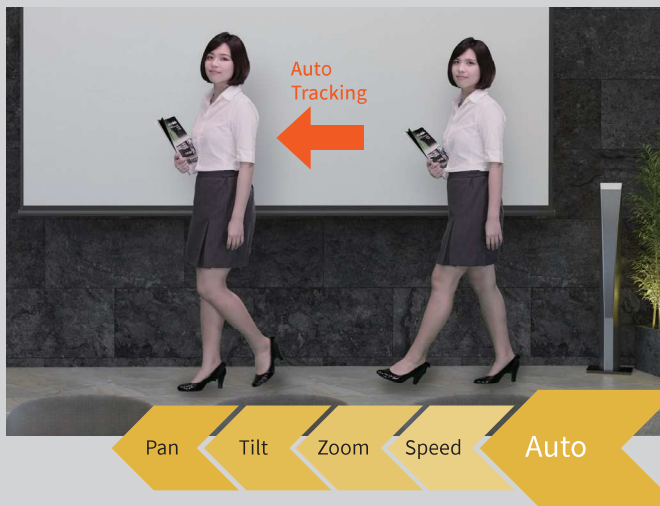

#### 「For ultimate camera movement」

In order to provide a professional smooth lens movement, Davideo has designed a professional AI algorithm that smoothly accelerates and decelerates the lens, determines the most appropriate lens track, and avoids sudden halts upon direction reversal, ultimately meeting your expectations and bringing you a professional production results. .



Zoom in



Zoom out

## Camera Control



Using an Ethernet cable, you will be able to control Datavideo's PTC camera series via the RS-232/422 or DVIP interface, such as pan and tilt settings, image size, brightness, contrast, etc, making sure that the cameras always generate high quality images.

Camera control

Save up to four presets

### Adjustment of white balance, focus, iris and shutter

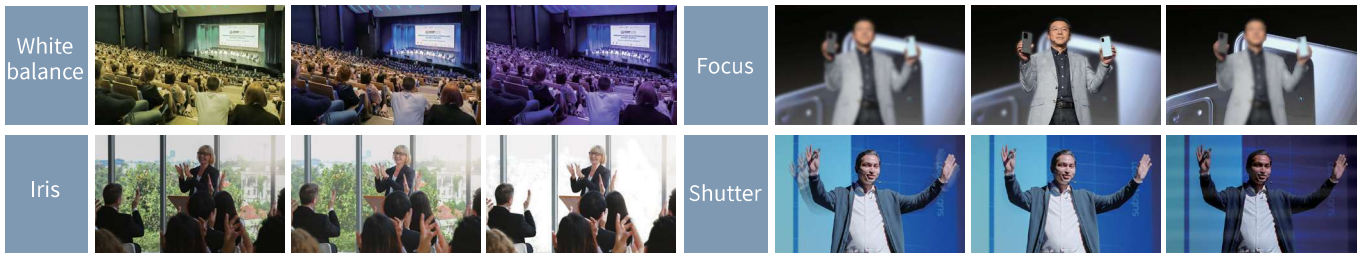

### Camera Control

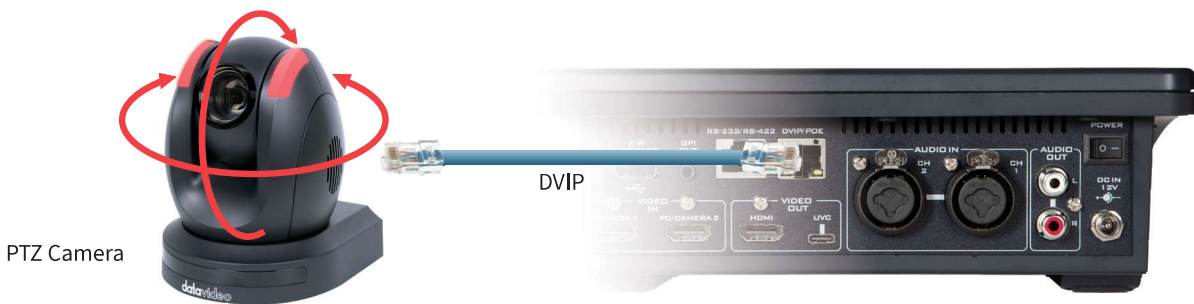

### Four camera presets





# PIP

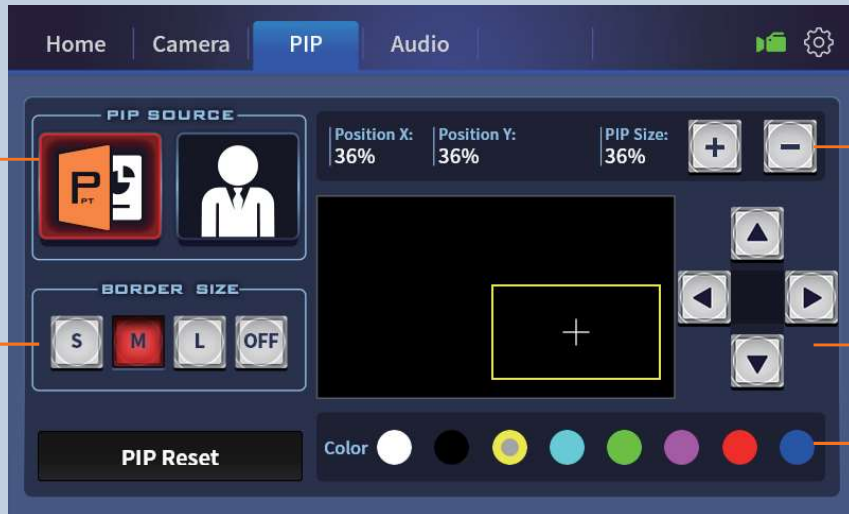

PIP video source

PIP window's size

PIP window's border size

Move the PIP window

PIP window's border color

## Set the PIP window's size and position

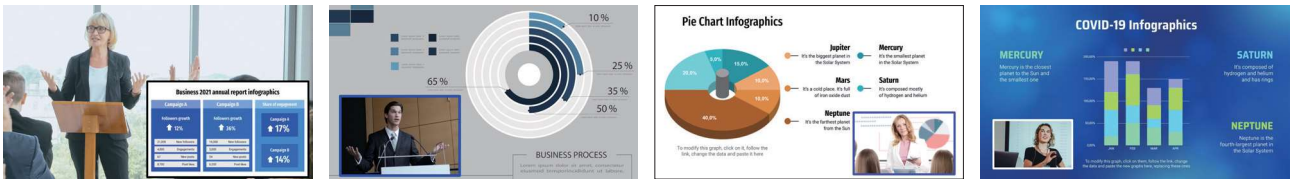

## Set the PIP window's border color

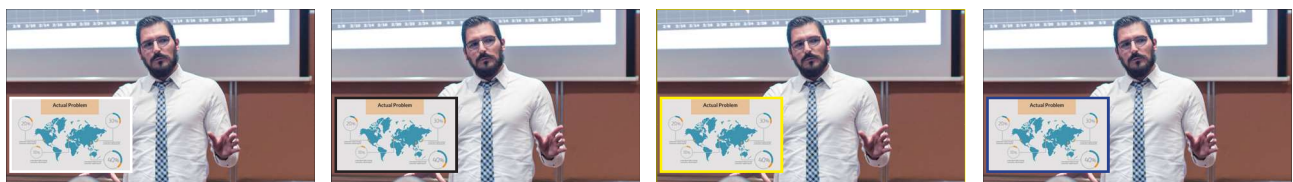

White

Black

Yellow

Blue

## Set the PIP window's border size



Non

Small

Middle

Big

## Volume Control



With so much emphasis on video related functions, you might think we don't care so much about the audio. Well, to Datavideo, the fact is that audio streaming is far more important than video streaming a professional production results. particularly in a hybrid classroom. As a result, three major audio features are integrated into the iCAST MINI and they are audio mixing, mic input format setting and audio-to-video synchronization. They solve issues that you may have to encounter every day.

## Audio Mixer



Stereo



Adjust audio delay



Audio mixer

The audio mixer allows you to synchronize audio across multiple multimedia sources, and adjust sound balance for your audio channels in order to achieve the right levels for video recording. With the configurable channel type, you can set the audio channel to either stereo or mono for a more balanced MIC input. Lastly, you can also synchronize live video and audio. You might have an unpleasant experience in video lagging audio while viewing live videos via streaming. With built-in audio delay, you can now set the delays for your audio channels which is a one time job to ensure your video and audio are always in sync.

# System diagram

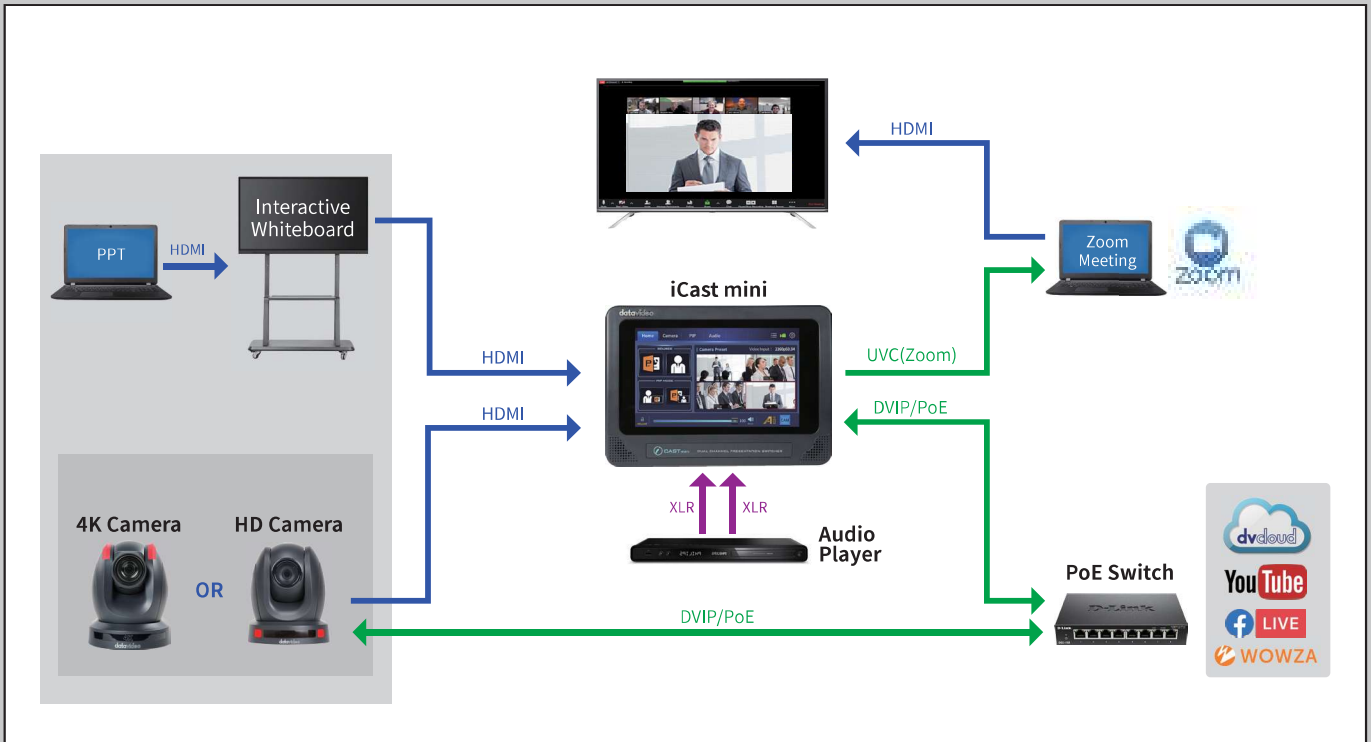

# Related Products



**PTC-140**  
1080P Camera

- 1/2.8 inch CMOS sensor.
- 1920x1080px Full HD resolution, 60fps
- 20x Optical Zoom, 10x Digital Zoom
- SDI/HDMI output
- H.264/H.265 streaming encoder
- Advanced 2D/3D noise reduction technology
- Compatible with various controllers: Datavideo PTZ View Assist APP, RMC-300 and RMC-180 series.



**PTC-145**  
1080P Camera

- 1/2.8 inch CMOS sensor.
- 1920x1080px Full HD resolution, 60fps
- 20x Optical Zoom, 10x Digital Zoom
- SDI/HDMI output
- H.264/H.265 streaming encoder
- Advanced 2D/3D noise reduction technology
- Compatible with various controllers: Datavideo PTZ View Assist APP, RMC-300 and RMC-180 series.



**PTC-280**  
4K Camera

- Supports up to 2160p50/60 via HDMI
- 12x Optical Zoom, 16x Digital Zoom
- 1/2.5" CMOS
- Built-in H.264/H.265 dual streaming encoder
- 2160p and 1080p(3G-SDI) simultaneous video output
- External audio input: 3.5mm audio or line in
- Compatible with various controllers: Datavideo PTZ View Assist APP, RMC-300 and RMC-180 series.



## Related Products



**PTC-285**

4K AI Camera

- Supports up to 2160p50/60 via HDMI
- One push to activate AI tracking which pans, tilts and zooms without human operations.
- 12x Optical Zoom, 16x Digital Zoom
- 1/2.5" CMOS
- Built-in H.264/H.265 dual streaming encoder
- 2160p and 1080p(3G-SDI) simultaneous video output
- External audio input: 3.5mm audio or line in
- Compatible with various controllers: Datavideo PTZ View Assist APP, RMC-300 and RMC-180 series.



**PTC-300**

4K Camera

- Supports up to 2160p50/60 via HDMI
- 20x Optical Zoom, 16x Digital Zoom
- 1/1.8" CMOS
- Built-in H.264/H.265 dual streaming encoder
- 2160p and 1080p(3G-SDI) simultaneous video output
- External audio input: 3.5mm audio or line in
- Compatible with various controllers: Datavideo PTZ View Assist APP, RMC-300 and RMC-180 series.



**PTC-305**

4K AI PTZ Camera

- 4K 50/60 YUV 422 Output •PTZ camera is equipped with Line IN and 3.5 mm phone jack.
- One push to activate AI tracking which pans, tilts and zooms without human operations.
- Stream to two streaming platforms at the same time.
- 1/1.8" CMOS 20x optical zoom and 16x digital zoom
- 3G-SDI supports LEVEL A/B to provide better device compatibility



**BC-15P/PN**

4K POV Camera

- 1/2.3" CMOS sensor with 4K 50/60p output, perfect for low light environment video production
- Low-latency SRT live output, support dvCloud ultra lowlatency cloud switching
- Power over Ethernet supported
- Small box design makes it flexible to be mounted anywhere.
- Swappable Fixed Lens Built-in
- Support two types of controls: physical buttons, and APP



**BC-15C/CN**

4K CS Mount POV Camera

- 1/2.3" CMOS sensor with 4K 50/60p output, perfect for low light environment video production
- Low-latency SRT live output, support dvCloud ultra lowlatency cloud switching
- Power over Ethernet supported
- Standard CS mount interchangeable lens design
- Supports DC-IRIS function
- Small box design makes it flexible to be mounted anywhere.
- Support two types of controls: physical buttons, and APP



**PTR-10/10T MARK III**

Robotic Pan Tilt Head

- Turn camcorder into PTZ
- Multiple signal interface: SDI, HDMI, RS-232, RS-422, DVIP/ HDBaseT, Tally, LANC
- Diversified controller options: RMC-180, RMC-300, and HS-1600T series
- Control of Pan, Tilt, Zoom
- Support optional Datavideo ZEK-1 Zoom Encoder Kit, and ZEK-2 to detect and read out the Zoom position of cameras on top
- Max. Camera Weight 4kg

# Specification

Model Name	iCAST Mini
Product Name	4K Dual Channel Presentation Switcher
Video Standard	4K & HD
Video Format	<p>Input:</p> <p>3840x2160p: 30/29.97/25/24/23.98                      1080p: 60/59.94/50/30/29.97/25/24/23.98                      1080i: 60/59.94/50, 720p: 60/59.94/50                      525i59.94 NTSC, 625i50 PAL</p> <p>Output:</p> <p>HDMI                      3840x2160p: 30/29.97/25                      1080p: 60/59.94/50/30/29.97/25/24/23.98                      UVC                      3840x2160p: 30/29.97/25                      1080p60/59.94/50/30/29.97/25                      720p60/59.94/50</p>
Video Processing	4K2K30 4:4:4, 8bit
Input Routable / Crosspoint	N/A
Video Input	2 x HDMI 1.4
Computer Graphic Interface	2 via HDMI
Video Output	1 x HDMI 1.4 1 x USB 3.0 Type C (UVC)
Down-converted Output	Yes
Analogue Audio Input	2 x 3 Pin XLR / 1/4" (6.3mm) Combo Socket
Analogue Audio Output	1 x Stereo RCA set (L/R) 1 x Stereo headphone
Digital Embedded Audio Support	Input 2 channels, Output 2 channels
Audio Delay Calibration	Up to 170ms
A+V Switching	Yes
Picture in Picture	1
Effects	Cut
Camera Control	DVIP/ RS-422/ RS-232
Built-in Audio Mixer	Yes
Firmware Update	USB
Special Features	7" Touchscreen Display
Chassis	Unibody
Dimension (LxWxH)	220x154x75
Weight	1.1 kg
Power	DC 12V 18.7W
Operating Temp. Range	0~40 °C
What's in the Box	1 x iCast MINI product 1 x AD Switch DC 12V with AC Cord

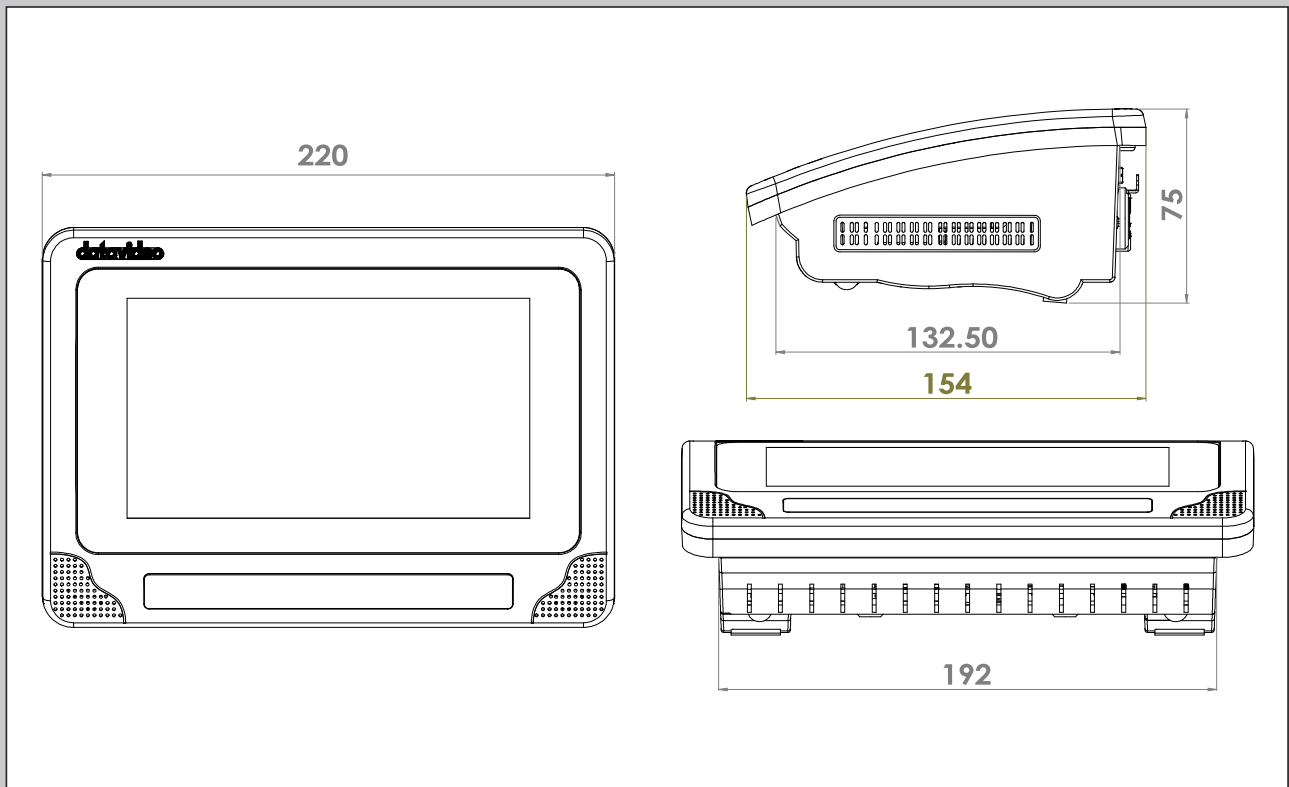



@DatavideoUSA @DatavideoAsia  
@DatavideoEMEA @DatavideoIndia2016  
@DatavideoTaiwan @Datavideojapan



@Datavideo  
@Datavideo\_EMEA  
@Datavideo\_Taiwan



@DatavideoUSA  
@DVTWDVCN



@DatavideoUSA  
@DatavideoEurope

---

**Disclaimers of Product and Services**

This brochure is intended as a guide only. We reserve the right to change specifications and availability without prior notice. While we strive for complete accuracy, be aware that it may contain errors and omissions. Prior to purchase, please check with your local Datavideo office or authorised distributor.

Ver.20230109