

datavideo

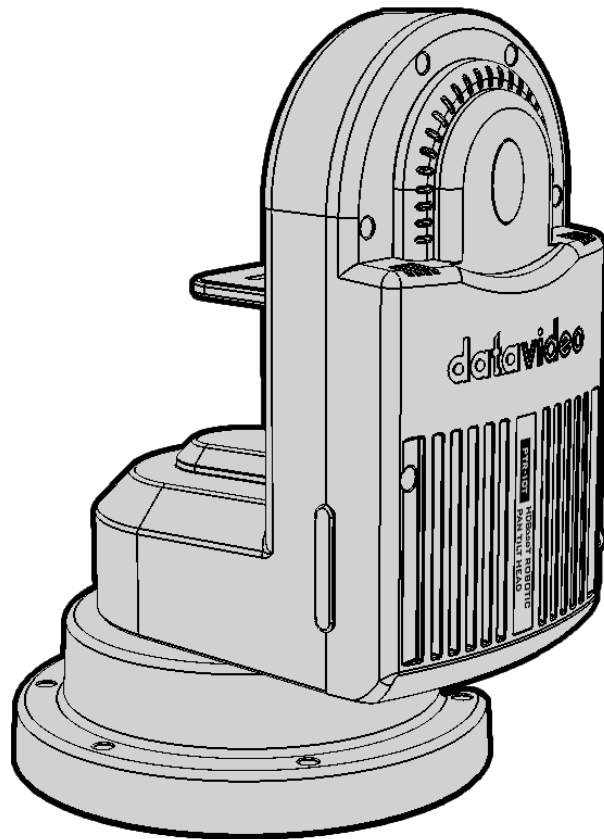

**ROBOTIC
PAN TILT HEAD**

PTR-10

Instruction Manual

www.datavideo.com

Table of Contents

FCC COMPLIANCE STATEMENT	4
WARNINGS AND PRECAUTIONS	4
WARRANTY	5
<i>STANDARD WARRANTY.....</i>	<i>5</i>
<i>THREE YEAR WARRANTY</i>	<i>5</i>
DISPOSAL	6
PRODUCT OVERVIEW.....	7
<i>FEATURES.....</i>	<i>7</i>
SYSTEM DIAGRAM	8
SYSTEM OVERVIEW	9
CONNECTIONS	12
<i>POWER.....</i>	<i>12</i>
<i>VIDEO.....</i>	<i>12</i>
CONTROL FUNCTIONS.....	13
<i>RS-422 VISCA COMMUNICATION PROTOCOL (RMC-180)</i>	<i>13</i>
<i>DVIP (RMC-300C)</i>	<i>14</i>
<i>REMOTE.....</i>	<i>15</i>
<i>TALLY</i>	<i>16</i>
<i>IR REMOTE CONTROL.....</i>	<i>17</i>
<i>Function Descriptions.....</i>	<i>18</i>
<i>OSD Menu</i>	<i>21</i>
DIP SWITCH.....	28
LED INDICATORS	29
FIRMWARE UPDATE.....	30
<i>FIRMWARE UPGRADE REQUIREMENTS</i>	<i>30</i>
<i>UPGRADE PROCEDURE.....</i>	<i>30</i>
FREQUENTLY-ASKED QUESTIONS	31
DIMENSIONS.....	32
SPECIFICATIONS.....	33
SERVICE AND SUPPORT.....	36

Disclaimer of Product & Services

The information offered in this instruction manual is intended as a guide only. At all times, Datavideo Technologies will try to give correct, complete and suitable information. However, Datavideo Technologies cannot exclude that some information in this manual, from time to time, may not be correct or may be incomplete. This manual may contain typing errors, omissions or incorrect information. Datavideo Technologies always recommend that you double check the information in this document for accuracy before making any purchase decision or using the product. Datavideo Technologies is not responsible for any omissions or errors, or for any subsequent loss or damage caused by using the information contained within this manual. Further advice on the content of this manual or on the product can be obtained by contacting your local Datavideo Office or dealer.

FCC Compliance Statement

This device complies with part 15 of the FCC rules. Operation is subject to the following two conditions:

- (1) This device may not cause harmful interference, and
- (2) This device must accept any interference received, including interference that may cause undesired operation.

Warnings and Precautions

1. Read all of these warnings and save them for later reference.
2. Follow all warnings and instructions marked on this unit.
3. Unplug this unit from the wall outlet before cleaning. Do not use liquid or aerosol cleaners. Use a damp cloth for cleaning.
4. Do not use this unit in or near water.
5. Do not place this unit on an unstable cart, stand, or table. The unit may fall, causing serious damage.
6. Slots and openings on the cabinet top, back, and bottom are provided for ventilation. To ensure safe and reliable operation of this unit, and to protect it from overheating, do not block or cover these openings. Do not place this unit on a bed, sofa, rug, or similar surface, as the ventilation openings on the bottom of the cabinet will be blocked. This unit should never be placed near or over a heat register or radiator. This unit should not be placed in a built-in installation unless proper ventilation is provided.
7. This product should only be operated from the type of power source indicated on the marking label of the AC adapter. If you are not sure of the type of power available, consult your Datavideo dealer or your local power company.
8. Do not allow anything to rest on the power cord. Do not locate this unit where the power cord will be walked on, rolled over, or otherwise stressed.
9. If an extension cord must be used with this unit, make sure that the total of the ampere ratings on the products plugged into the extension cord do not exceed the extension cord rating.
10. Make sure that the total amperes of all the units that are plugged into a single wall outlet do not exceed 15 amperes.
11. Never push objects of any kind into this unit through the cabinet ventilation slots, as they may touch dangerous voltage points or short out parts that could result in risk of fire or electric shock. Never spill liquid of any kind onto or into this unit.
12. Except as specifically explained elsewhere in this manual, do not attempt to service this product yourself. Opening or removing covers that are marked "Do Not Remove" may expose you to dangerous voltage points or other risks, and will void your warranty. Refer all service issues to qualified service personnel.



13. Unplug this product from the wall outlet and refer to qualified service personnel under the following conditions:
- a. When the power cord is damaged or frayed;
 - b. When liquid has spilled into the unit;
 - c. When the product has been exposed to rain or water;
 - d. When the product does not operate normally under normal operating conditions. Adjust only those controls that are covered by the operating instructions in this manual; improper adjustment of other controls may result in damage to the unit and may often require extensive work by a qualified technician to restore the unit to normal operation;
 - e. When the product has been dropped or the cabinet has been damaged;
 - f. When the product exhibits a distinct change in performance, indicating a need for service.

Warranty

Standard Warranty

- Datavideo equipment is guaranteed against any manufacturing defects for one year from the date of purchase.
- The original purchase invoice or other documentary evidence should be supplied at the time of any request for repair under warranty.
- The product warranty period begins on the purchase date. If the purchase date is unknown, the product warranty period begins on the thirtieth day after shipment from a Datavideo office.
- All non-Datavideo manufactured products (product without Datavideo logo) have only one year warranty from the date of purchase.
- Damage caused by accident, misuse, unauthorized repairs, sand, grit or water is not covered under warranty.
- Viruses and malware infections on the computer systems are not covered under warranty.
- Any errors that are caused by unauthorized third-party software installations, which are not required by our computer systems, are not covered under warranty.
- All mail or transportation costs including insurance are at the expense of the owner.
- All other claims of any nature are not covered.
- All accessories including headphones, cables, batteries, metal parts, housing, cable reel and consumable parts are not covered under warranty.
- Warranty only valid in the country or region of purchase.
- Your statutory rights are not affected.

Three Year Warranty

- All Datavideo products purchased after July 1st, 2017 qualify for a free two years extension to the standard warranty, providing the product is registered with Datavideo **within 30** days of purchase.
- Certain parts with limited lifetime expectancy such as LCD panels, DVD drives, Hard Drive, Solid State Drive, SD Card, USB Thumb Drive, Lighting, Non-PCIe Card and third party provided PC components are covered for 1 year.



- The three-year warranty must be registered on Datavideo's official website or with your local Datavideo office or one of its authorized distributors within 30 days of purchase.

Disposal

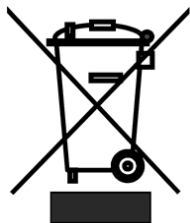

For EU Customers only - WEEE Marking

This symbol on the product or on its packaging indicates that this product must not be disposed of with your other household waste. Instead, it is your responsibility to dispose of your waste equipment by handing it over to a designated collection point for the recycling of waste electrical and electronic equipment. The separate collection and recycling of your waste equipment at the time of disposal will help to conserve natural resources and ensure that it is recycled in a manner that protects human health and the environment. For more information about where you can drop off your waste equipment for recycling, please contact your local city office, your household waste disposal service or the shop where you purchased the product.



CE Marking is the symbol as shown on the left of this page. The letters "CE" are the abbreviation of French phrase "Conformité Européene" which literally means "European Conformity". The term initially used was "EC Mark" and it was officially replaced by "CE Marking" in the Directive 93/68/EEC in 1993. "CE Marking" is now used in all EU official documents.

Product Overview

Datavideo's PTR-10 is a revolutionary robotic pan tilt head designed specifically for mounting small-to-midsized cameras, allowing you to control them from a remote location.

Datavideo's PTR-10 robotic pan tilt head weighs 3.4 Kg and allows mounting of a camera that weighs up to 4 Kg, thus making it a perfect device to be mounted on the tripod, the wall and the ceiling. Ultimately, PTR-10 gives you everything you need to maneuver your camera in different scenarios.

That's Datavideo; sharing the value!

Features

Video Input Interfaces

- SDI
- HDMI

Video Output Formats

- 2160p 29.97/25
- 1080p 59.94/50
- 1080i 59.94/50
- 720p 59.94/50

Control Interfaces

- RS-232
- RS-422
- DVIP
- Tally
- LANC

Compatible Datavideo Controllers

- RMC-180
- RMC-300C
- HS-1600T
- RMC-280

Supported Cameras

- Datavideo block cameras
- LANC cameras
- BX lens cameras

Others





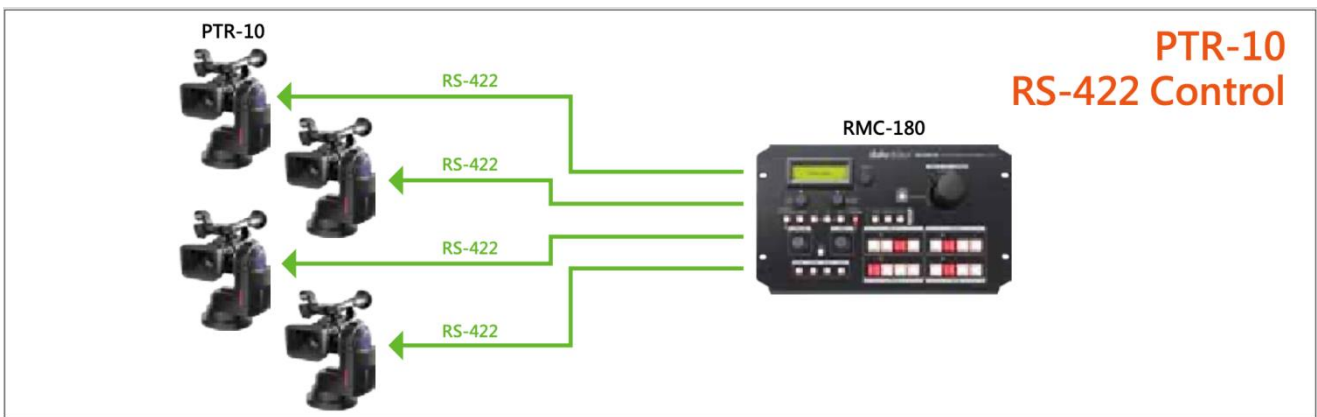
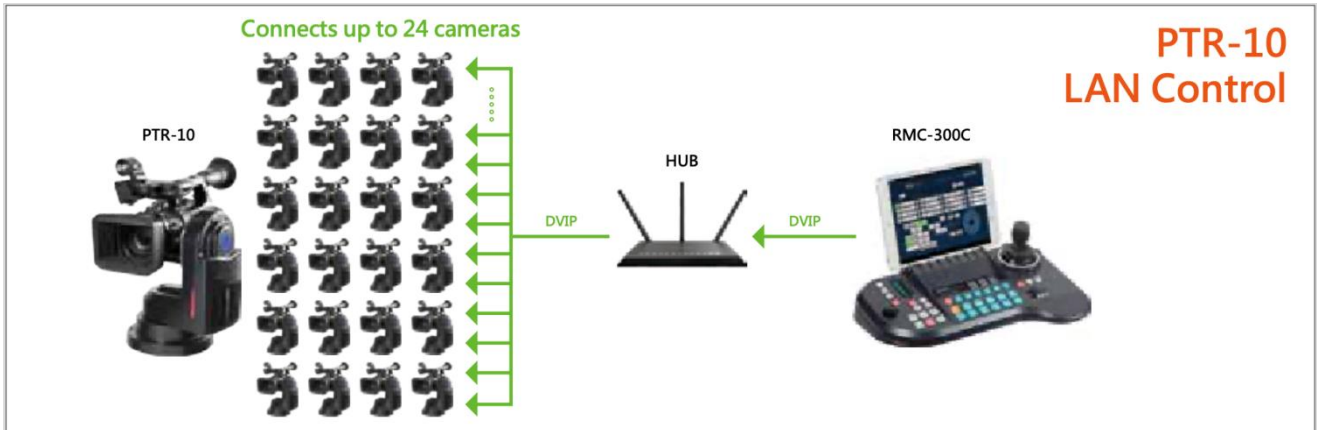



- PAN and TILT adjustments
- Strong and sturdy aluminum alloy material design
- Built-in tally light





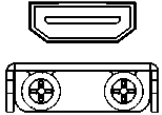
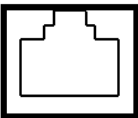

System Diagram

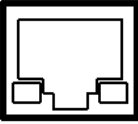
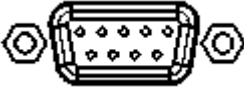

System Overview

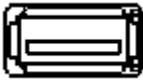

Power		
1		DC 12V/5A IN DC in socket connects the supplied 12V/5A PSU. The connection can be secured by screwing the outer fastening ring of the DC In plug to the socket.
2		Power Switch Device power ON/OFF
3		DC 12V/2A OUT Supplies power to the mounted camera.
Video		
4		SDI IN Video IN from the mounted camera
5		SDI OUT Delivers camera video to external devices such as a video switcher.
6		HDMI IN Video IN from the mounted camera
7		HDMI OUT Delivers camera video to external devices such as a video switcher.
Control		
8		RS-422 IN Connects any VISCA controller utilizing RS-422 interface such as Datavideo's RMC-180 controller. <i>See the section on RS-422 VISCA Communication Protocol for detailed descriptions and example system setup.</i>
9		RS-422 OUT Connects to the camera mounted, relaying messages between the camera and VISCA controller (RMC-180).

10		<p>DVIP DVIP port connects the PTR-10 to an Ethernet switcher or router for remote control. An example of the controller utilizing DVIP port is RMC-300C. <i>See the section on DVIP for detailed descriptions and example system setup.</i></p>
11		<p>RS-232 OUT Currently a reserved port for future development.</p>
12		<p>REMOTE For adjusting zoom and focus of various camera brands</p>
13		<p>Tally IN Receives tally information from external devices such as a video switcher.</p>
14		<p>Tally OUT Delivers tally information to the mounted camera.</p>
15		<p>IR Receiver Operate the PTR-10 by an IR remote control.</p>
Firmware Upgrade / Device Configuration		
16		<p>F/W Upgrade For upgrading to the latest firmware <i>See Firmware Update</i></p>
17		<p>LED Indicators Firmware update status indications <i>See LED Indicators</i></p>
18		<p>DIP Switch For configuring the PTR-10. <i>See DIP Switch</i></p>

Connections

Before starting to use your robotic pan tilt head, make sure you have connected the power and camera video.

Power

DC 12V/5A IN

DC in socket connects the supplied 12V/5A PSU. The connection can be secured by screwing the outer fastening ring of the DC In plug to the socket.

DC 12V/2A OUT

Supplies power to the mounted camera.

Video

SDI / HDMI IN

Video IN from the mounted camera via SDI or HDMI interface.

SDI / HDMI OUT

Delivers camera video to external devices such as a video switcher via SDI or HDMI interface.

Control Functions

Various control methods are described in this section.

RS-422 VISCA Communication Protocol (RMC-180)

The RMC-180 PTZ Camera Controller is designed to control up to 4 Datavideo Pan Tilt Zoom (PTZ) cameras such as the PTC-150/PTC-150W.

To control the PTZ camera mounted on PTR-10, first connect one of the four RJ-45 ports provided on the RMC-180 rear to PTR-10's RS-422 IN port via any RJ-45 cable. Via another RJ-45 cable, connect PTR-10's RS-422 OUT port to RS-422 port of the PTZ camera mounted. See the diagram below for example system setup and refer to the RMC-180 user manual for instructions.

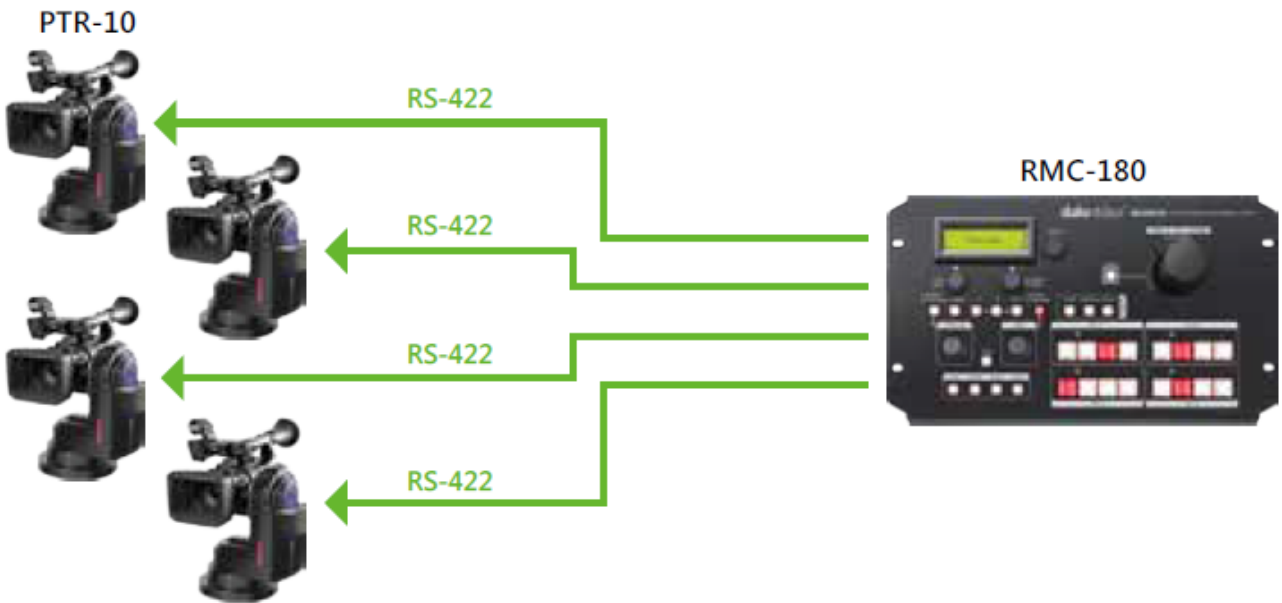

Please note that bit 4 of the DIP switch must be set to OFF. See the [DIP Switch](#) section for detailed information.



See below for information about RJ-45 cabling (RS-422 wiring scheme between RMC-180 and PTR-10) in the RS-422 setup environment.

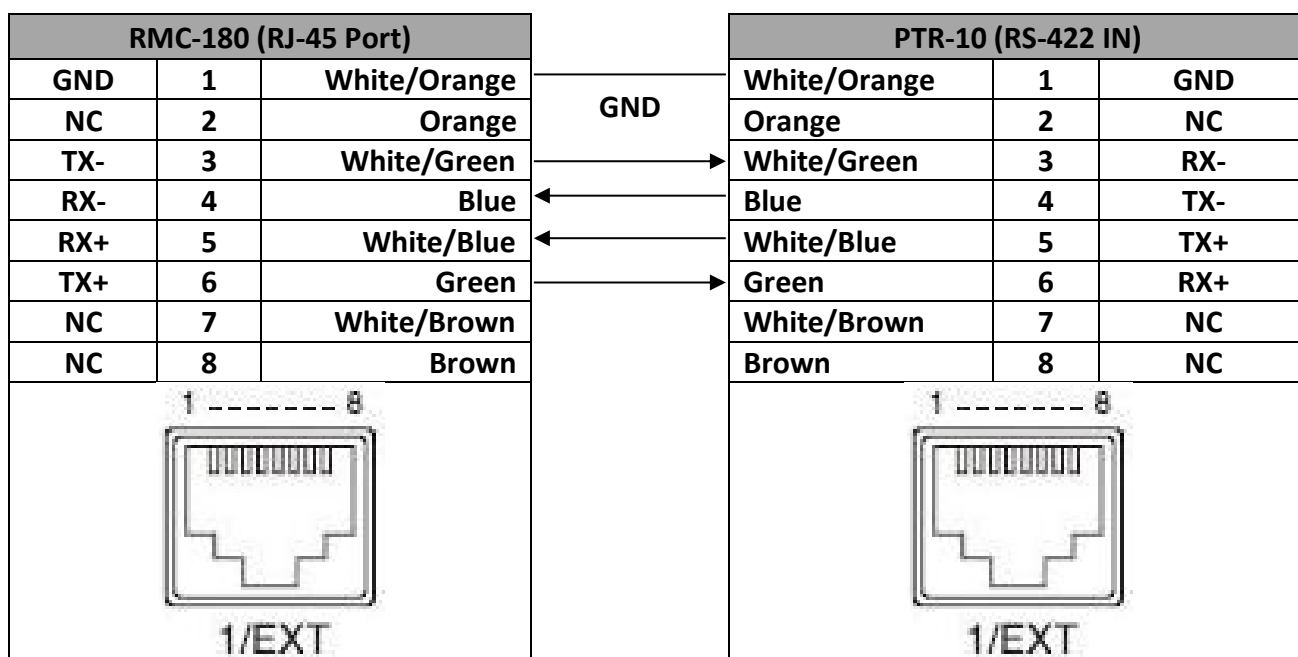

DVIP (RMC-300C)

To control multiple PTR series devices with the RMC-300C, you will first have to connect them to the same network via DVIP port. The RMC-300C allows you to control up to 24 PTR series devices simultaneously. See the diagram below for an example system connection setup in a DHCP / LAN network and also refer to the RMC-300C user manual for instructions.

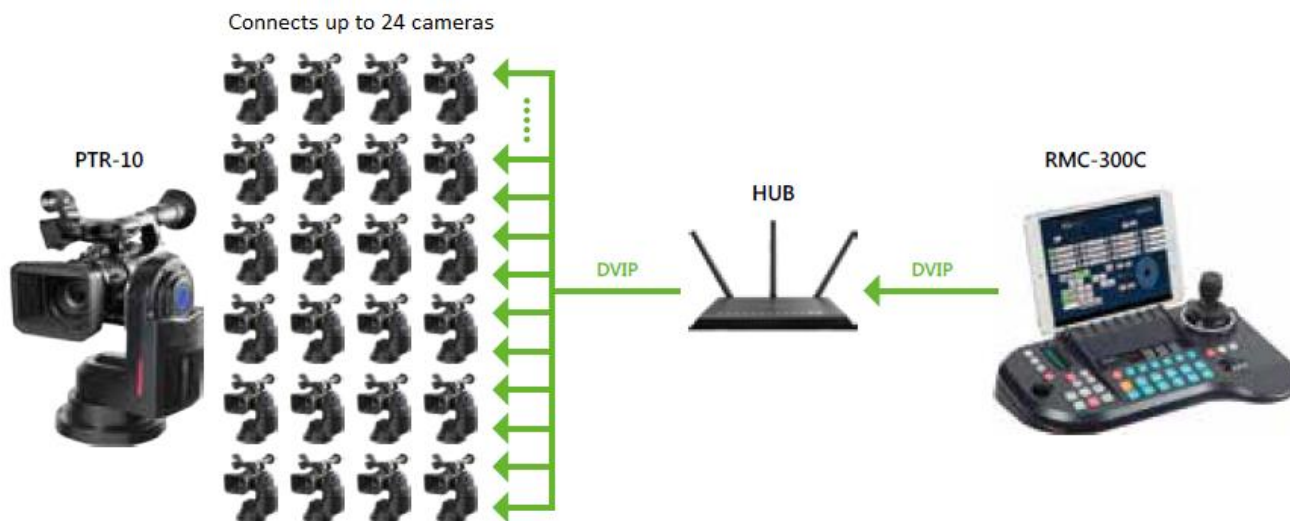

PTR series device usually has a default static IP address of 192.168.100.XXX. Using an RJ-45 Ethernet cable, the unit can be directly connected to a Windows-based computer assigned of an IP address with the same first three octets as the unit’s default IP address. The following setup procedure outlined below should allow you to initially configure the unit before moving it to an existing DHCP / LAN network.

1. First using an RJ-45 Ethernet cable, connect the **DVIP port** of your PTR series device to a Windows computer assigned of an IP address with the same first three octets as the device's default IP address.
2. Locate the DIP switch on your PTR series device.

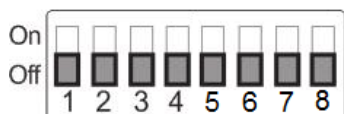

3. Set DIP Switch positions X and X to ON.

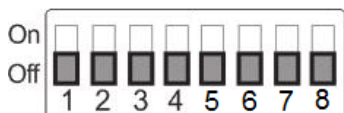

4. Set **DVIP baud rate** to 115200.
5. Download the DVIP Configuration Tool from the product page.
6. On the PC, open the DVIP Configuration Tool by double clicking **"DVIP_ConfigureTools.exe."**
7. After the DVIP Configuration Tool is opened, select your network interface card and click the **"OK"** button.
8. On the DVIP Device List, you will then be able to see the Device Name, MAC address and IP address of the connected device.
9. Set the network to DHCP then click the **"Save"** button to write the new setting into the device.
10. Right after the **"Save"** button is clicked, you will be able to see a prompt message at the top right corner to request for a device reboot for the new settings to become effective.
11. Reboot the device to apply the new settings.



Remote

The **Remote** port, when connected to the camera mounted, allows you to adjust ZOOM and FOCUS of various camera brands. To use this function, first enable LANC or BX-Lens mode by accessing the OSD menu on your PTR-10 device

4. Remote Control
 - 6. Set Remote Out
 - 1. Remote Out mode
 - LanC or BX-Lens

Once the LANC mode is enabled, connect the PTR-10 Remote port to the camera's 2.5 mm earphone jack. Below is a list of cameras that you may be able to adjust the Zoom and Focus in LANC mode.

Sony	PXW-Z280V PXW-Z190V PXW-Z150 PXW-X160	Handheld Camcorder – 4K HDR
------	--	-----------------------------

HNR-NX5R
HNR-NX100

Canon XF305
XF405

JVC GY-HC550/500
GY-HM171K
GY-HM606
GY-HM660

If the BX-Lens mode is selected, use Sony 8 pin to 8 pin remote control cable to establish device connection, which allows you to adjust the zoom function.

Tally

Two tally sockets can be found on your PTR series device. **Tally IN** receives tally information from external devices such as a video switcher. **Tally OUT** delivers tally information to the mounted camera.

Tally Light Definitions

Message	On Air/Live	Standby/Cued	Free/Safe
Light	Red	Green	No Light

A simple test tool is illustrated in the diagram below.

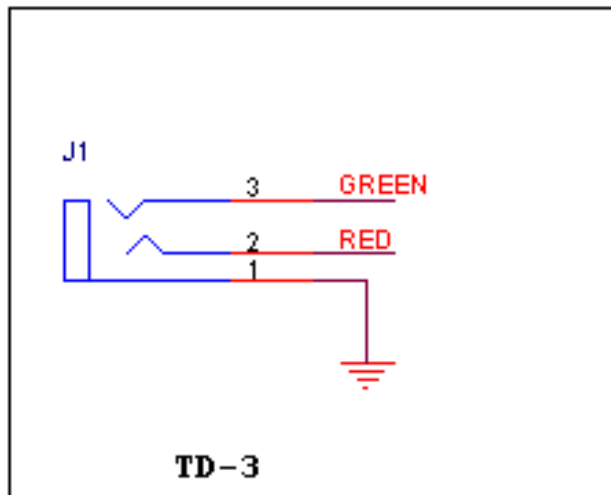
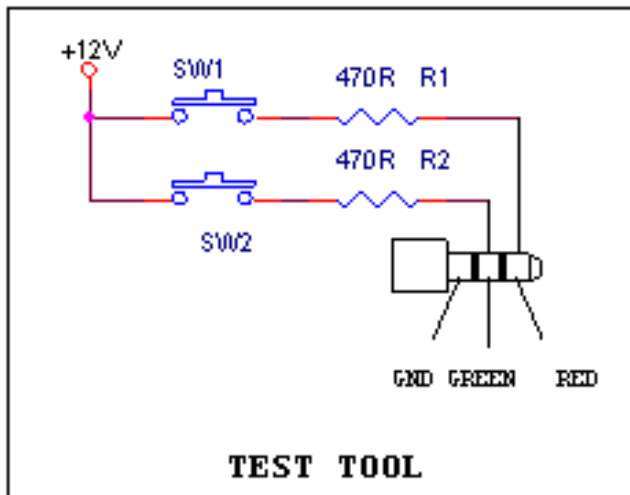





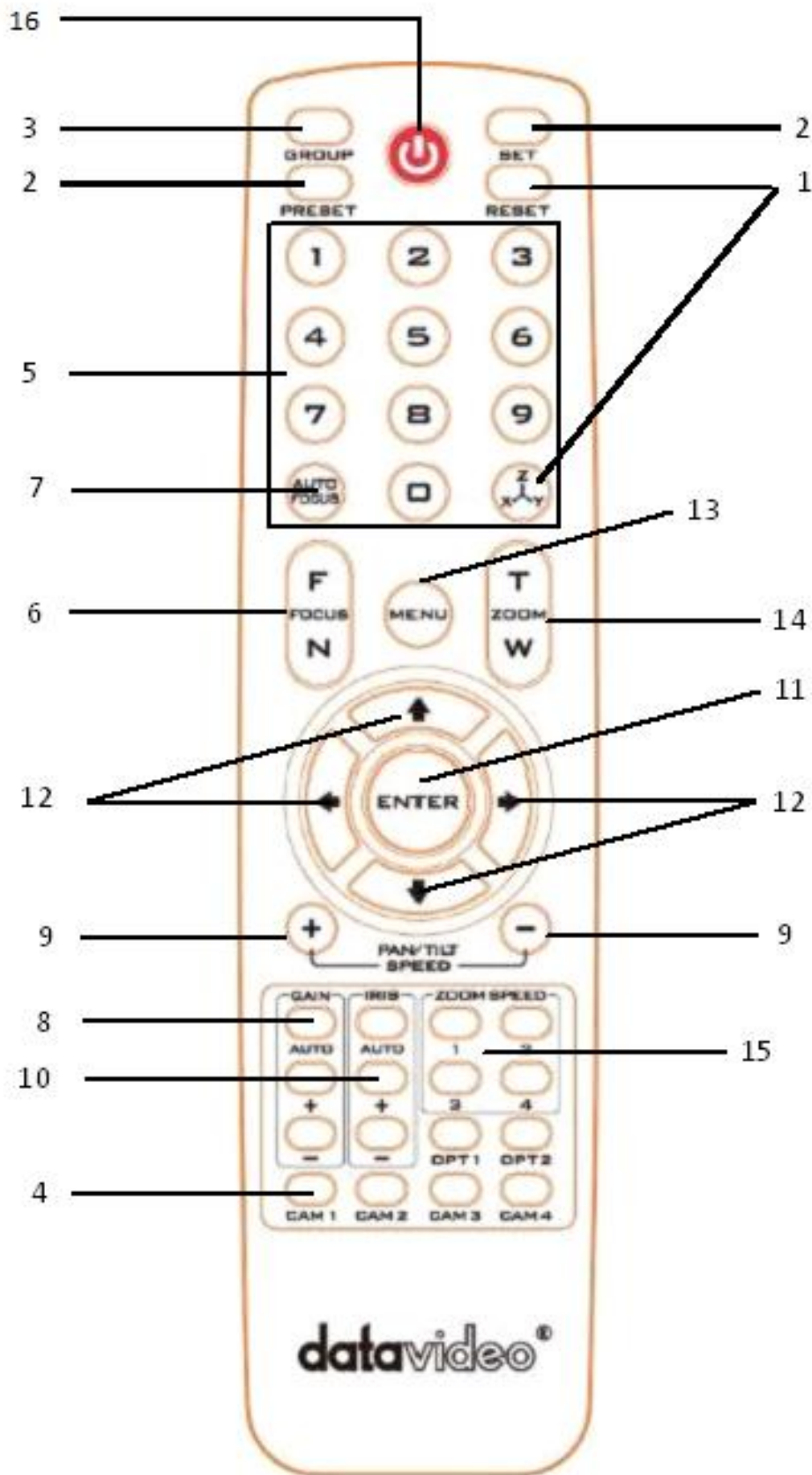





IR Remote Control





Operates PTR-10 by an IR remote control.





Function Descriptions

No.	Buttons	Descriptions
1	<p>Reset</p> 	<p>Press RESET button to return the camera lens to the front.</p>
2	<p>Set</p>  <p>Preset</p> 	<p>Saving PAN/TILT Presets The PTR-10 is equipped with 50 PAN/TILT presets. To save PAN/TILT settings to presets, you should first move the camera to a desired PAN/TILT position then press the number keys to select a preset number (1-50). Finally press the SET button to store the PAN/TILT settings (Note: You can also issue the save command using the RS-422 protocol).</p> <p>Recalling PAN/TILT Presets First press the number keys to select a preset number (1-50) then press the PRESET button to recall the PAN/TILT settings.</p>
2	<p>Group</p> 	<p>Enabling the GROUP motion activates automatic camera movements. Each group consists of up to 16 PAN/TILT presets allowing automatic movement of cameras to these positions in the order configured in the group.</p> <p>Recalling Group The PTR-10 is equipped with 8 groups. To recall a group, first press the number keys to select a group number (1-8) then press the GROUP button to enable it.</p> <p>Saving Group Settings To configure the group setting, first open the OSD menu, then select MEMORY.</p> <p>Each group allows you to select up to 16 presets from the PRESET NO. option for automatic movements of the camera mounted. You can set the stop time for each preset. Furthermore, in the NEXT POSITION option, set RETURN to repeat the group motion and the rest for single group motion.</p> <p>Group Cancel Press Enter or Reset button to terminate GROUP motion.</p>
3	<p>Camera Select</p> 	<p>Select CAM1-CAM4 in a multi-camera environment Assign an ID number to the camera intended for operation by adjusting the IRID (SW2) switch located at the rear of the camera</p> <p>Press CAMERA SELECT (CAM 1~ CAM4) buttons corresponding to the numbers set previously to navigate between four cameras</p>

No.	Buttons	Descriptions
4	<p>Position Setting</p> 	<p>Various combinations of settings (position, zoom, focus, gain control and iris control) can be saved to presets using the number keypad.</p> <p>Adjust Preset Point Adjust position, zoom, focus, gain control and iris of the camera.</p> <p>Set up Preset Point Press any of the preset numbers 1~50 and then press the SET button (see the SET button description).</p> <p>Recall saved setting Press any of the preset numbers 1~50 and then press the PRESET button (see the PRESET button description).</p> <p>Set up Group Scan mode Press any of the group numbers 1~8 and then press the GROUP button (see the GROUP button description).</p> <p>Return Camera Lens to the Front Press number 0 and then press PRESET button.</p>
5	<p>Focus Setup</p> 	<p>Manually focus camera lens on a subject Press either (F) FAR button or (N) NEAR button to manually focus the camera lens onto the subject.</p>
6	<p>Auto Focus Control</p> 	<p>Automatically focus camera lens on a subject Press the Auto FOCUS button to automatically focus the camera lens onto the subject such that it is positioned at the center of the screen.</p>
7	<p>Gain Control</p> 	<p>Adjust Brightness Press GAIN+ button to increase the brightness or GAIN- button to decrease the brightness of the environment.</p> <p>To cancel the function or return to default setup, press the Auto button.</p>
8	<p>P/T Speed</p> 	<p>Adjust Pan/ Tilt Speed Press SPEED + / - button to switch to adjust Pan/Tilt speed (up/down).</p>

No.	Buttons	Descriptions
9	<p>Auto Iris Control</p> 	<p>Make the subject appear brighter Adjust the iris opening (aperture), to control the amount of light coming through the lens (i.e. the "exposure"). Press IRIS+ button to enlarge the iris opening to allow more light to come in so that the subject appears brighter and press IRIS- button to shrink the iris opening to allow less light to come in so that the subject appears less bright.</p> <p>To cancel the function or return to default setup, press the Auto button.</p>
10	<p>ENTER</p> 	<p>ENTER Menu ENTER key</p>
11	<p>Direction Arrows</p> 	<p>Change camera direction Press arrow buttons to change the direction of the camera head</p> <p>Stop Preset Point Auto Scan mode Press any of the DIRECTION buttons</p> <p>Select Menu Option Press UP or DOWN button to select the menu option</p> <p>Enter Sub-Menu Option Press ENTER button to enter sub- menu option</p> <p>Adjust Setup Value Press LEFT or RIGHT button to adjust the value</p>
12	<p>Menu Button</p> 	<p>Enter or Exit Menu Options</p>
13	<p>Zoom In / Out Buttons</p> 	<p>Zoom Press either (T) TELE button to zoom in on the subject such that it appears to be close to the camera or (W) WIDE button to zoom out from the subject such that it appears to be far away from the camera.</p>

No.	Buttons	Descriptions
14	Zoom Speed Button (4 speed selection) 	Adjust Zoom In/Out Speed Press button 1/2/3/4 to switch between different speeds with 1 being the highest and 4 being the lowest.
15	Power Button 	Switch Remote Controller ON/OFF

OSD Menu

The OSD menu allows you to modify various device settings such as pan and tilt and control protocols. Press the menu button on your remote control opens the OSD menu shown below.

OSD MENU 1: Set Motor 2: Memory 3: Video Mode 4: Remote Control 5: System 6: Reset P/T 7: Escape

The table below summarizes the main option items and their sub-options.

Main Options							
	Set Motor	Memory	Video Mode	Remote Control	System	Reset P/T	Escape
Sub-Options	1. P/T Acceleration	1. Preset Position	1. Selection Way	1. PAN/TILT Reverse	1. Display	Reset Pan/Tilt	
	2. P/T Speed	2.Group-1	2. Video Mode	2. Remote Source	2. Tally Light		
	3. PAN Torque	3. Group-2	3. HDMI Mode	3. Set RS-422	3. Model No.		
	4. Tilt Torque	4. Group-3	4. Escape	4. Set DVIP	4. Reset All		
	5. Pan Offset	5. Group-4		5. Set IR	5. Update Software		
	6. Tilt Offset	6. Group-5		6. Set Remote Out	6. Escape		
	7. Pan Min Limit	7. Group-6		7. PTZ INFO. output			

Main Options						
Set Motor	Memory	Video Mode	Remote Control	System	Reset P/T	Escape
8. Pan Max Limit	8. Group-7		8. Escape			
9. Tilt Min Limit	9. Group-8					
10. Tilt Max Limit	10. Escape					
11. Escape						

Details of all options in the on-screen menu are listed in the table below.

First Level Main Options	Second Level Sub-Options	Third Level Parameters	Fourth Level Parameters	Sub-Option Description	
1. Set Motor	P/T Acceleration	Fast			
		Slow			
		Middle			
	P/T Speed		X4, Super Fast		
			X2, Surveillance		
			Normal		
			1/2, Low		
	PAN torque ADJ		LOW		
			+1~+5		
	TILT torque ADJ		LOW		
			+1~+5		
	PAN Offset ADJ		+5.4		
			+4.5		
			+3.6		
			+2.7		
			+1.8		
			+0.9		
			0.0		
			-0.9		
			-1.8		
			-2.7		
			-3.6		
			-4.5		
			-5.4		
	TILT Offset ADJ		+6.3		
			+5.4		
			+4.5		
			+3.6		
			+2.7		
			+1.8		
			+0.9		
			0.0		
-0.9					

First Level Main Options	Second Level Sub-Options	Third Level Parameters	Fourth Level Parameters	Sub-Option Description	
		-1.8			
		-2.7			
		-3.6			
		-4.5			
		-5.4			
		-6.3			
	PAN Min Limit	-170 – -1			
	PAN Max Limit	+1 – +170			
	TILT Min Limit	-45 – -1			
	TILT Max Limit	+45 – +1			
7. Escape					
2. Memory	1. Preset Position	1-50 P/T	1. P/T Speed	1 – 18	
		51. ESCAPE	2. Escape		
	2. Group – 1	1-16		PRESET NO.	1~50
				ITEM ON/OFF	ON/OFF
				SPEED LIMIT	1~18
				WAITING TIME	0~180
				NEXT POSITION	NEXT ITEM
					RETURN
					GROUP – 1
					GROUP – 2
					GROUP – 3
					GROUP – 4
					GROUP – 5
					GROUP – 6
				GROUP – 7	
	GROUP – 8				
	ESCAPE				
	17. ESCAPE				
	3. Group – 2	1-16		PRESET NO.	1~50
				ITEM ON/OFF	ON/OFF
				SPEED LIMIT	1~18
				WAITING TIME	0~180
				NEXT POSITION	NEXT ITEM
					RETURN
					GROUP – 1
					GROUP – 2
					GROUP – 3
GROUP – 4					
GROUP – 5					
GROUP – 6					
GROUP – 7					
GROUP – 8					
ESCAPE					
17. ESCAPE					

First Level Main Options	Second Level Sub-Options	Third Level Parameters	Fourth Level Parameters	Sub-Option Description
	4. Group – 3	1-16	PRESET NO.	1~50
			ITEM ON/OFF	ON/OFF
			SPEED LIMIT	1~18
			WAITING TIME	0~180
			NEXT POSITION	NEXT ITEM
				RETURN
				GROUP – 1
				GROUP – 2
				GROUP – 3
				GROUP – 4
				GROUP – 5
				GROUP – 6
			GROUP – 7	
			GROUP – 8	
			ESCAPE	
			17. ESCAPE	
			5. Group – 4	1-16
	ITEM ON/OFF	ON/OFF		
	SPEED LIMIT	1~18		
	WAITING TIME	0~180		
	NEXT POSITION	NEXT ITEM		
		RETURN		
		GROUP – 1		
		GROUP – 2		
		GROUP – 3		
		GROUP – 4		
		GROUP – 5		
		GROUP – 6		
	GROUP – 7			
	GROUP – 8			
	ESCAPE			
	17. ESCAPE			
	6. Group – 5	1-16		
ITEM ON/OFF			ON/OFF	
SPEED LIMIT			1~18	
WAITING TIME			0~180	
NEXT POSITION			NEXT ITEM	
			RETURN	
			GROUP – 1	
			GROUP – 2	
			GROUP – 3	
			GROUP – 4	
			GROUP – 5	
			GROUP – 6	
GROUP – 7				
GROUP – 8				

First Level Main Options	Second Level Sub-Options	Third Level Parameters	Fourth Level Parameters	Sub-Option Description		
			ESCAPE			
		17. ESCAPE				
	7. Group – 6	1-16	PRESET NO.	1~50		
			ITEM ON/OFF	ON/OFF		
			SPEED LIMIT	1~18		
			WAITING TIME	0~180		
			NEXT POSITION	NEXT ITEM		
				RETURN		
				GROUP – 1		
				GROUP – 2		
				GROUP – 3		
				GROUP – 4		
				GROUP – 5		
				GROUP – 6		
			GROUP – 7			
			GROUP – 8			
	ESCAPE					
	17. ESCAPE					
	8. Group – 7	1-16	PRESET NO.	1~50		
			ITEM ON/OFF	ON/OFF		
			SPEED LIMIT	1~18		
			WAITING TIME	0~180		
			NEXT POSITION	NEXT ITEM		
				RETURN		
				GROUP – 1		
				GROUP – 2		
				GROUP – 3		
				GROUP – 4		
				GROUP – 5		
				GROUP – 6		
GROUP – 7						
GROUP – 8						
ESCAPE						
17. ESCAPE						
9. Group – 8	1-16	PRESET NO.	1~50			
		ITEM ON/OFF	ON/OFF			
		SPEED LIMIT	1~18			
		WAITING TIME	0~180			
		NEXT POSITION	NEXT ITEM			
			RETURN			
			GROUP – 1			
			GROUP – 2			
			GROUP – 3			
			GROUP – 4			
			GROUP – 5			
			GROUP – 6			

First Level Main Options	Second Level Sub-Options	Third Level Parameters	Fourth Level Parameters	Sub-Option Description	
			ESCAPE	GROUP – 7	
				GROUP – 8	
		17. ESCAPE			
	10. Escape				
3. Video Mode	1. Selection Way	BY MENU			
		BY SWITCH			
	2. Video Mode	1080i59.94			
		1080i50			
		720p59.94			
		720p50			
		1080p59.94			
		1080p50			
		2160p29.97			
	2160p25				
3. HDMI Mode	RGB444				
	YUV422				
	5. Escape				
4. Remote Control	1. PAN/TILT Reverse	OFF			
		P			
		T			
		P+T			
	2. Remote Source	RS-422, SW (Configurable using bottom DIP switch ONLY)			
	3. Set RS-422	CAMERA ID MODE	BY MENU		
			BY SWITCH		
		CAMERA ID	1~7		
		RS-422 BAUD RATE	9600		
			19200		
			38400		
			115200		
	Recall's Response	Tailer			
		Leader			
	ESCAPE				
	4. Set DVIP	DVIP BAUD RATE	9600		
			19200		
			38400		
			115200		
	ESCAPE				
5. Set IR	IR GROUP ID	CAM1~4			
	ESCAPE				
6. Set Remote Out	Remote Out Mode	BX Lens			
		LANC			
		RS-232C			

First Level Main Options	Second Level Sub-Options	Third Level Parameters	Fourth Level Parameters	Sub-Option Description
		Remote Out Baud Rate	RS-422	
			9600	
			19200	
			38400	
		115200		
		Remote Out ID	1-7	
	ESCAPE			
	7. PTZ INFO. Output	ON/OFF		
8. Escape				
5. System	1. Display	P/T OSD	PAN OSD	ON/OFF
			TILT OSD	ON/OFF
			VZOOM OSD	ON/OFF
			ESCAPE	
		DEBUG OSD	DEBUG IR OSD	ON/OFF
			DEBUG RS-422 OSD	ON/OFF
			DEBUG DVIP OSD	ON/OFF
			DEBUG M_CTL OSD	ON/OFF
			DEBUG REG OSD	ON/OFF
			DEBUG FRAME NO	ON/OFF
			ESCAPE	
		2. Tally Light	RED/GREEN	
			GREEN	
	RED			
	OFF			
	3. Model No.	0150/0010		
	4. Reset All	YES/NO		
	5. Update Software	SW VERSION	ESCAPE	
		MB CPU	V00.49a	
		MCTL CPU	V00.31	
		UPDATE ALL	YES/NO	
		ESCAPE		
	6. Escape			
6. Reset Pan/Tilt	Reset Pan/Tilt	YES/NO		
7. Escape				

DIP Switch

The DIP Switch can be found on one of the system panels and allows the user to set the device's VISCA ID, enable remote control (DVIP or RS-422), select the output video resolution, and configure how the video mode can be selected. **See the table below for various settings.**

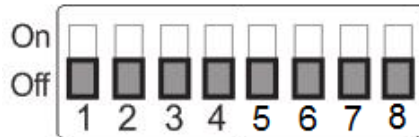

DIP SW 1/2/3	VISCA ID
(1,2,3) = (ON,OFF,OFF)	VISCA-ID 1
(1,2,3) = (OFF,ON ,OFF)	VISCA-ID 2
(1,2,3) = (ON ,ON ,OFF)	VISCA-ID 3
(1,2,3) = (OFF,OFF,ON)	VISCA-ID 4
(1,2,3) = (ON ,OFF,ON)	VISCA-ID 5
(1,2,3) = (OFF,ON ,ON)	VISCA-ID 6
(1,2,3) = (ON ,ON ,ON)	VISCA-ID 7
DIP SW 4	Remote Control Protocol
ON	DVIP
OFF	RS-422
DIP SW 5/6/7	Resolution
(5,6,7) = (OFF,OFF,OFF)	1920 x 1080i 59.94
(5,6,7) = (ON,OFF,OFF)	1920 x 1080i 50
(5,6,7) = (OFF,ON,OFF)	1280 x 720p 59.94
(5,6,7) = (ON,ON,OFF)	1280 x 720p 50
(5,6,7) = (OFF,OFF,ON)	1920 x 1080p 59.94
(5,6,7) = (ON,OFF,ON)	1920 x 1080p 50
(5,6,7) = (OFF,ON,ON)	3840 x 2160p 29.97
(5,6,7) = (ON,ON,ON)	3840 x 2160p 25
DIP SW 8	Video Mode Selection Method
ON	Video mode selectable by DIP switch only
OFF	Video mode selectable by OSD menu

LED Indicators

The table below shows the different status of the LEDs being steadily ON.



Red 1	Red 2	Green	Yellow
Received PAN control signal	Received TILT control signal	F/W Update Successful	System Operating

Firmware Update

Datavideo usually releases new firmware containing new features or reported bug fixes from time to time. Customers can either download the firmware as they wish or contact their local dealer or reseller for assistance.

This section outlines the firmware upgrade process which should take ***approximately few minutes to complete***.

The existing settings should persist through the *firmware upgrade process, which should not be interrupted once started* as this could result in a non-responsive unit.

Firmware Upgrade Requirements

- USB thumb drive
- Latest firmware files

Upgrade Procedure

1) Copy firmware image files (MB and MCTL) into the root directory of a USB hard drive (<16 GB) and insert it into the F/W Upgrade USB port.

2) Use the IR remote control to open the OSD menu.

Note: If you are using more than one camera in your environment, first select the camera by pressing the corresponding CAM button; the default is CAM1.



3) Main Menu

=> 5: SYSYEM

=> 5: UPDATE SOFTWARE

=> UPDATE ALL

=>YES

=> ENTER

4) Wait for another five minutes until the following lines appear on the screen

- Updated Mot-BD=>OK.
- Updated MCPU =>OK

The OSD menu screen will flash “Write OK/Power ON Again” alternately; the update process should take approximately 5-7 minutes to complete.

5) Turn off the device by unplugging the power cord and plug the power cord back into the socket to turn on the device again.

6) FW Update is complete.

Frequently-Asked Questions

This section describes problems that you may encounter while using PTR-10. If you have any questions, please refer to related sections and follow all suggested solutions. If problem still exists, please contact your distributor or the service center.

No.	Problems	Solutions
1.	The device stops responding unexpectedly.	When the PTR-10/10T is overloaded, the device power will be automatically disconnected. To resume power, first turn off the device, unplug the power cable for more than 15 seconds, then reconnect the power and turn on the device.
2	DC Out does not supply power.	Once the short circuit protection is activated to cut the power, you will need to reboot the device to resume supplying power to the camera.
3	How to prevent activation of short circuit protection after we start supplying power to the device.	We recommend establishing all cable connections to the camera first before switching ON the PTR-10.

Dimensions

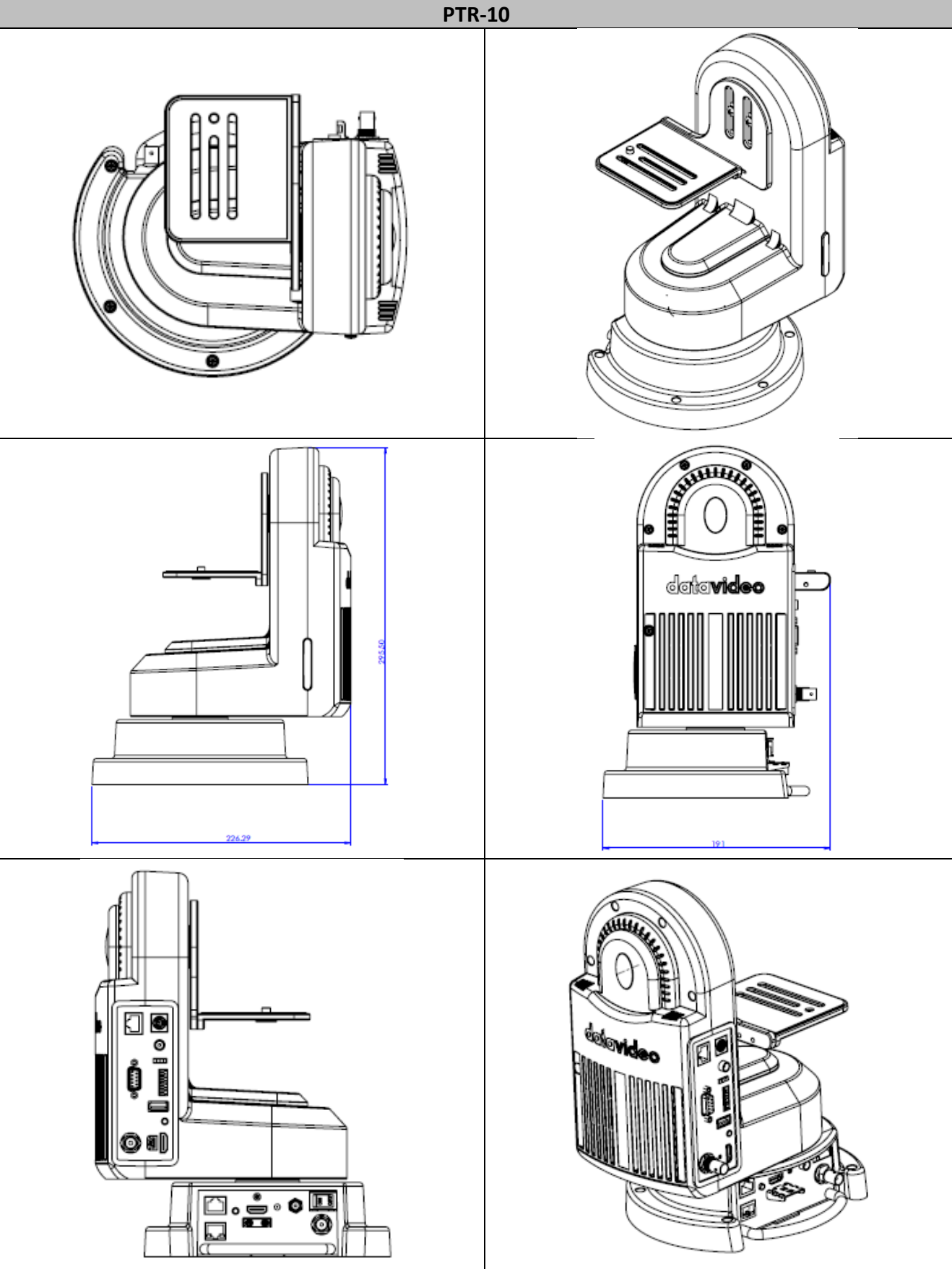

All measurements in millimeters (mm)

Specifications

Product Name	Robotic Pan Tilt Head
Model Number	PTR-10
Video Input Interface	HDMI x 1 3G-SDI x 1
Video Output Interface	HDMI x 1 3G-SDI x 1
Video Output Format	2160p 29.97/25 1080p 59.94/50 1080i 59.94/50 720p 59.94/50
Supported Controller	RMC-180 / RMC-300C VISCA Controller IP Control IR Remote
PAN/TILT Range	PAN: 340° MAX TILT: +45° to -45° MAX
PAN/TILT Speed	Manual: 0.2 – 15° / Sec Swing: 0.1 – 10° / Sec
Presets	50 PAN/TILT positions
Control Protocol	Sony VISCA DVIP
Control Interface	RS-422 / DVIP
Control Distance	RS-422: 1200 m DVIP: 100 m
Max Load	4.0 Kg
Power Supply	DC 12V – 18V / 3A (Without Camera) DC 12V – 18V / 5A (With Camera)
Output Power	DC 12V / 2A Max
Operating Temp.	0 – 40°C
Weight	3.4 Kg
Dimensions (L x W x H)	230 x 190 x 300 mm

Notes

Notes

Service & Support

It is our goal to make owning and using Datavideo products a satisfying experience. Our support staff is available to assist you to set up and operate your system. Contact your local office for specific support requests. Plus, please visit www.datavideo.com to access our FAQ section.



Please visit our website for latest manual update.

www.datavideo.com/product/PTR-10

datavideo
www.datavideo.com



@DatavideoUSA @DatavideoIndia2016
@DatavideoEMEA @Datavideojapan
@DatavideoTaiwan @DatavideoLatam
@DatavideoAsia @DatavideoBrasil



@Datavideo
@Datavideo_EMEA
@Datavideo_Taiwan



@DatavideoUSA
@DVTWDCN



@DatavideoUSA
@DatavideoEurope

All the trademarks are the properties of their respective owners.
Datavideo Technologies Co., Ltd. All rights reserved 2020

Mar-16,2020
Version E2